

REV	DESCRIPTION	DRW.	DATE
00	初版发行	M.C.N	2022.11.14

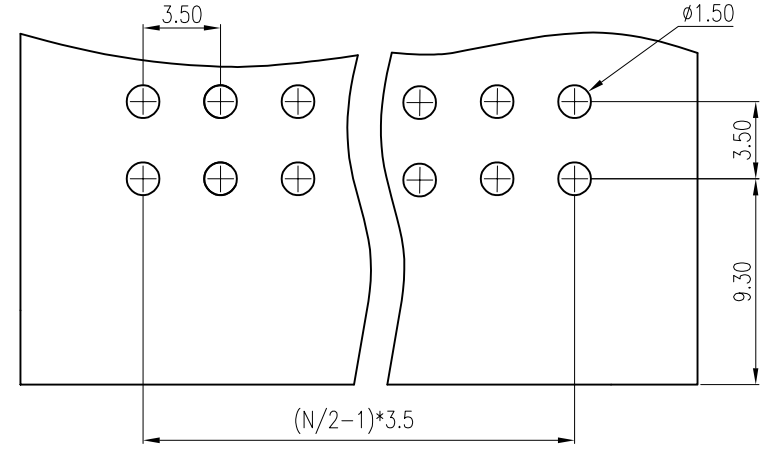
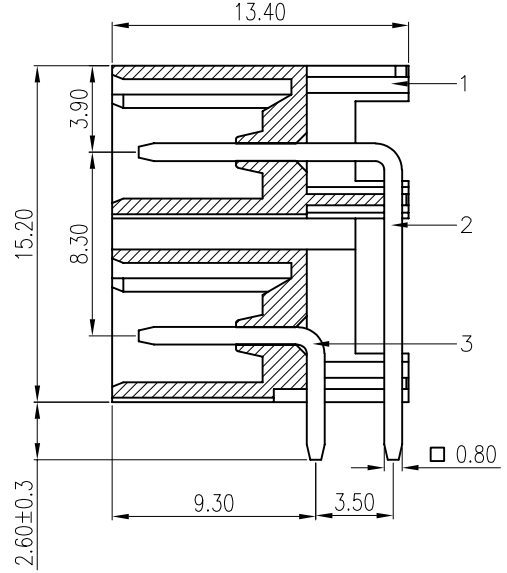
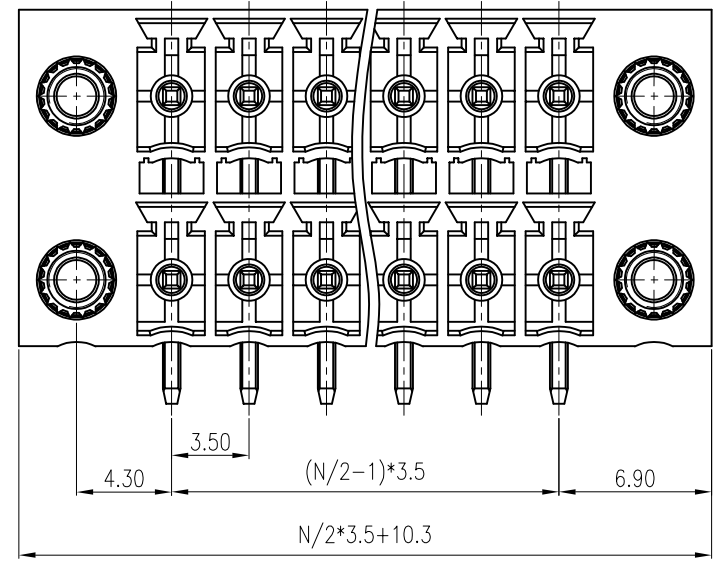

Notes/备注:

1. Electrical properties/电气特性
UL Standard/UL标准

Use Group/应用组别	B	C	D
Rated Voltage/额定电压 (V)	300	/	300
Rated Current/额定电流 (A)	8	/	8
Withstanding voltage/工频耐电压	AC 1600V/1Min		

IEC Standard/IEC标准

Rated Voltage/额定电压 (V): 320
Rated Current/额定电流 (A): 10

Overvoltage Category/过电压类别 /Pollution Degree/污染等级	II/2	III/2	III/3
Voltage/电压 (V)	320	160	160
Rated Impulse Voltage/冲击耐电压 (KV)	2.5	2.5	2.5

2. Environmental safety/环境安全

Operating temperature/工作温度范围 (°C): -40~+105
RoHS compliant/符合RoHS环保要求

Part No./料号说明:

F8ERM-3.5-XXP-X

Poles/P数	Color/颜色
02: 2Poles	1: Brown/棕色 6: Blue/蓝色
04: 4Poles	2: Red/红色 7: Purple/紫色
...	3: Orange/橙色 8: Grey/灰色
24: 24Poles	4: Yellow/黄色 9: White/白色
	5: Green/绿色 A: Black/黑色

ITEM	NAME OF PART	MATERIAL	NOTES
4	NUT 螺母	Copper Alloy	/
3	PIN HEADER 焊针	Copper Alloy	Sn Plated
2	PIN HEADER 焊针	Copper Alloy	Sn Plated
1	HOUSING 主体	PA66+CF25	UL94 V-0

Nominal dimension Tolerances (mm)							
0	over 18	over 30	over 50	over 80	over 120	over 180	over 250
to 18	to 30	to 50	to 80	to 120	to 180	to 250	to 320
	±0.25	±0.3	±0.35	±0.5	±0.7	±0.9	±1.0
							±1.2

APP.	DATE:	PART NO.: F8ERM-3.5-XXP-X	
CHK.	DATE:		
DRW. M.C.N	DATE: 2022.11.14	DARWING TYPE: Customer Drawing	
PROJECTION		UNITS: mm	SCALE: 4:1 SHEET/OF: 1/1
		昆山艾尼维尔电子有限公司 KUN SHAN AINEWELL ELECTRONICS CO.,LTD	